

# The Basics of Exception Handling

MIPS uses two coprocessors: **C0** and **C1** for additional help. C0 primarily helps with **exception handling**, and C1 helps with **floating point** arithmetic. Each coprocessor has a few registers.

## **Interrupts**

Initiated outside the instruction stream

Arrive asynchronously (at no specific time),

Example:

- I/O device status change
- I/O device error condition

## **Traps**

Occur due to something in instruction stream.

Examples:

- Unaligned address error
- Arithmetic overflow
- System call

**MIPS coprocessor C0** has a **cause register** (Register 13) that contains a 4-bit code to identify the cause of an **exception**

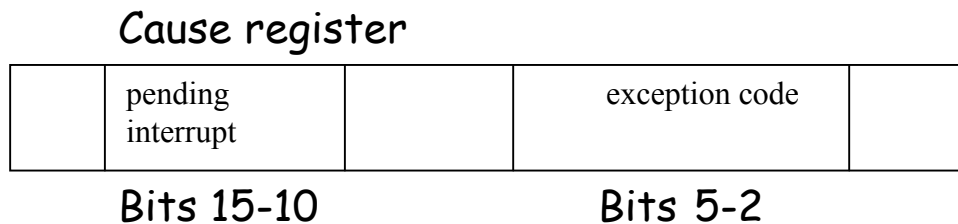

[Exception Code = 0 means I/O interrupt  
 = 12 means arithmetic overflow etc]

MIPS instructions that cause overflow (or some other violation) lead to an **exception**, which sets the **exception code**. It then switches to the **kernel mode** (designated by a bit in the **status register** of C0, register 12) and transfers control to a predefined address to invoke a routine (**exception handler**) for handling the exception.

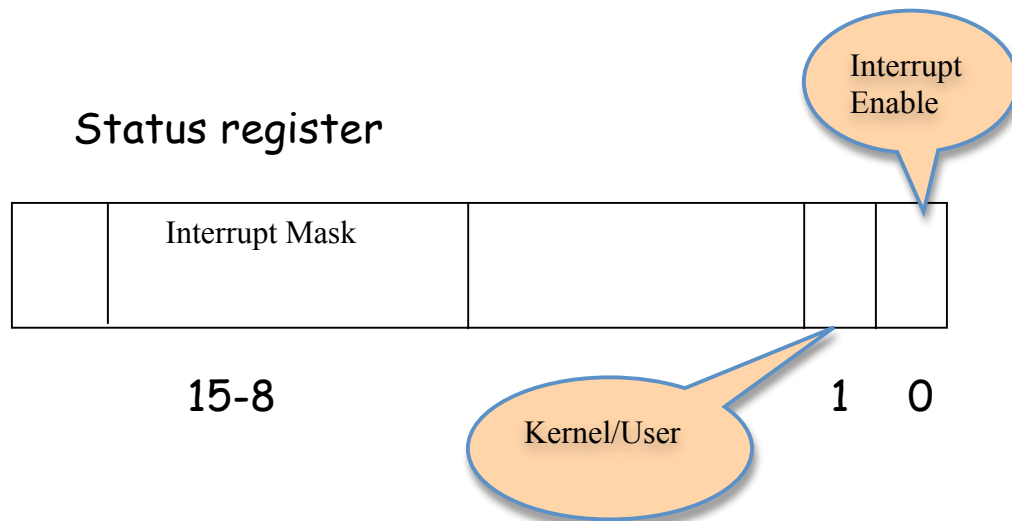

(EPC = Exception Program Counter, Reg 14 of C0)

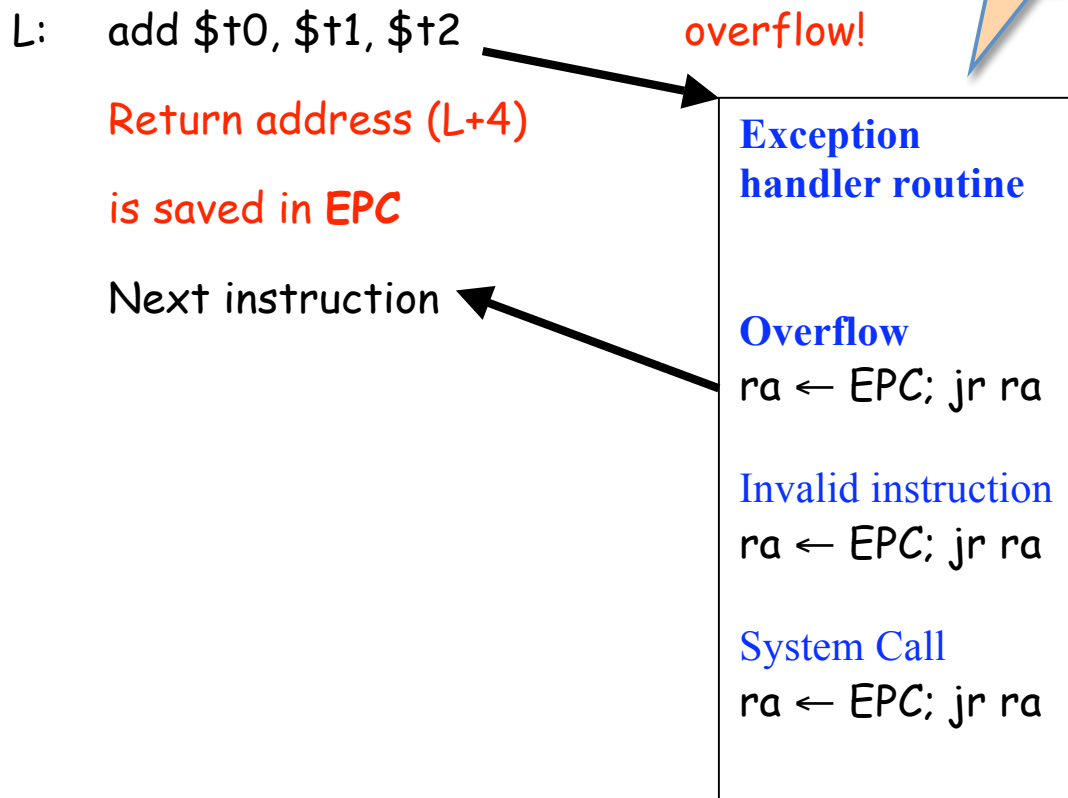

The Exception Handler determines the cause of the exception by looking at the **exception code** bits. Then it jumps to the appropriate exception handling routine. Finally, it returns to the main program.

Exceptions cause mostly **unscheduled procedure calls**.

## Example: Read one input from a Keyboard

Consider reading a value from the **keyboard**. Assume that the **interrupt enable** bit is set to 1. The first line, `".text 0x80000080"` places the code explicitly at the memory location where the *interrupt service routine* is called.

```
.text    0x80000080
        mfc0 $k0, $13        # $k0 = $Cause;
        mfc0 $k1, $14        # $k1 = $EPC;
        andi $k0, $k0, 0x003c # $k0 &= 0x003c (hex);
                                   # Filter the Exception Code;
        bne $k0, $zero, NotIO # if ($k0 == 0) go to NotIO
                                   # Exception Code 0 => I/O intr.
        sw $ra, save0($0)    # save0 = $ra;
        jal ReadByte         # ReadByte(); (Get the byte).
        lw $ra, save0($0)    # $ra = save0;
        jr $k1               # return;
NotIO:   Other routines here
```

Note that procedure `ReadByte` must save all registers that it plans to use, and restore them later.

# Understanding Logic Design

Appendix C of your Textbook on the CD

When you write `add $t0, $t1, $t2`, you imagine something like this:

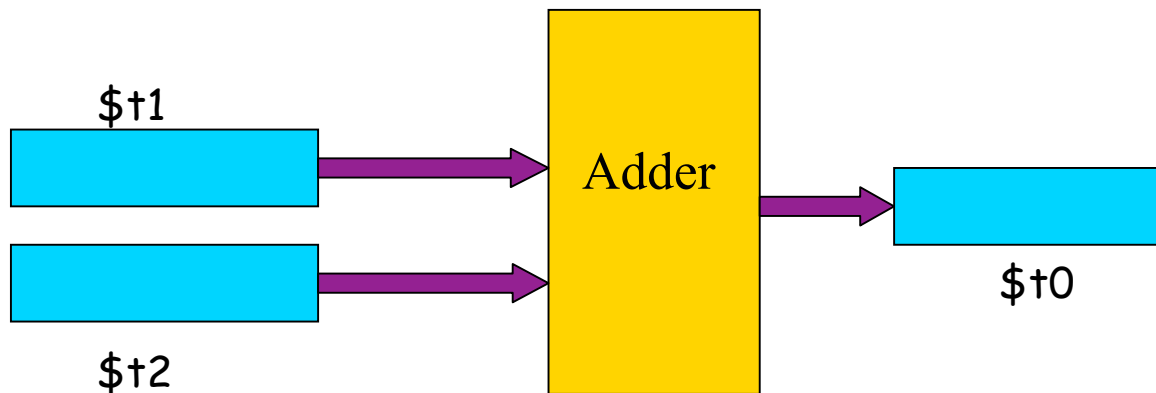

What kind of hardware can ADD two binary integers?

We need to learn about *GATES* and *BOOLEAN ALGEBRA* that are foundations of logic design.

## AND gate

X	Y	X.Y
0	0	0
0	1	0
1	0	0
1	1	1

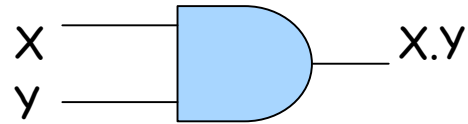

## OR gate

X	Y	X+Y
0	0	0
0	1	1
1	0	1
1	1	1

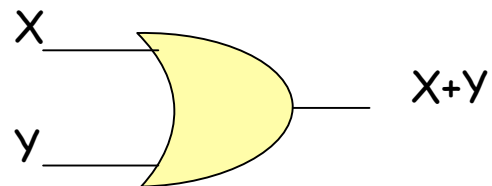

## NOT gate

X	$\overline{X}$
0	1
1	0

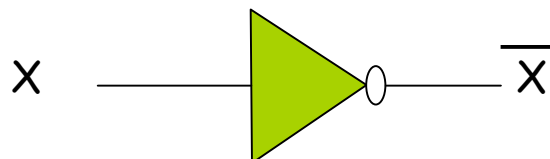

Typically, logical 1 = +3.5 volt, and logical 0 = 0 volt. Other representations are possible.

## Analysis of logical circuits

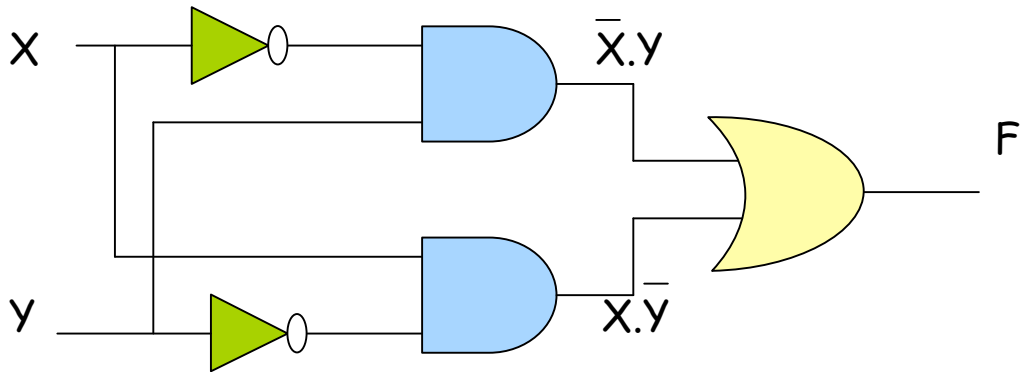

What is the value of F when X=0 and Y=1?

Draw a truth table.

X	Y	F
0	0	0
0	1	1
1	0	1
1	1	0

This is the **exclusive or** (XOR) function. In algebraic

form  $F = \bar{X}.Y + X.\bar{Y}$

## More practice

1. Let  $\bar{A}.B + A.C = 0$ . What are the values of  $A, B, C$ ?
2. Let  $(A + B + C).(A + B + C) = 0$ . What are the possible values of  $A, B, C$ ?

- Draw truth tables.
- Draw the logic circuits for the above two functions.

